

## LED Linear Light

TL-LL

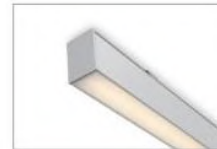
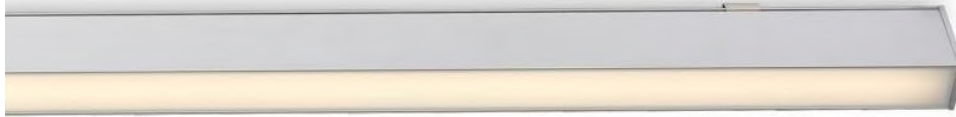

### Features:

- LED linear lights for suspension, surface-mount & recessed installation
- Simple to install & replace
- Up to 80% energy saving
- Lower maintenance cost
- UV & IR free light
- CRI>80
- 100lm/W
- On-off & dimmable 1-10V versions available
- 3000K, 4000K OR 5000K
- Black or white housing color
- PF0.9
- IP20

### Applications:

- Schools
- Offices
- Commercial & retail stores
- Hotels
- Supermarkets
- Banks

**General Characteristics:**

PRODUCT CODE	POWER (W)	VOLTAGE	Lumen Output (lm)	CCT (K)	CRI	PRODUCT DIMENSION	TYPE
TL-LL40W	40W	110-240V/50-60Hz	4000	3000K-5000K	80	L1200xW40xH75mm	Surface-mount/Suspension
TL-LL40W	40W	110-240V/50-60Hz	4000	3000K-5000K	80	L1200xW40xH75mm	Recessed



Caution:

- Please read the contents on the box and label carefully before installation.
- Check if the specification e.g. voltage, current etc meet the requirements.
- Power must be cut off before installation, replacement and cleaning.
- Don't touch the luminaire while it is on or immediately after turning it off. Please wait 15 min. to cool down.

Remarks:

- Power consumption tolerance: +/- 10%
- Luminous flux & cd tolerance: +/-10%

\*Photos, descriptions and details of the product are subject to change without previous notice.

## LED Linear Light

### TL-LL55



#### Features:

- Elegant linear light, combining optical & mechanical design to achieve a soft & uniform light
- Reflector, opal & UGR
- Surface-mount, suspension & recessed installation
- Simple to install & replace
- Continuous row installation & linkable using connectors
- Up to 80% energy saving
- Lower maintenance cost
- UV & IR free light
- CRI>80 OR CRI>90
- 100lm/W, 120lm/W or 140lm/W
- On-off & dimmable versions available
- 24W, 40W, 48W
- Length of 1124mm or 1404mm
- 3000K, 4000K, 5700K
- White, grey or black housing color
- PF0.95
- IP20
- Screw free end cap
- Up lighting module optional
- CCT color switch also available



**Applications:**

- Schools
- Offices
- Commercial & retail stores
- Hotels
- Supermarkets
- Banks

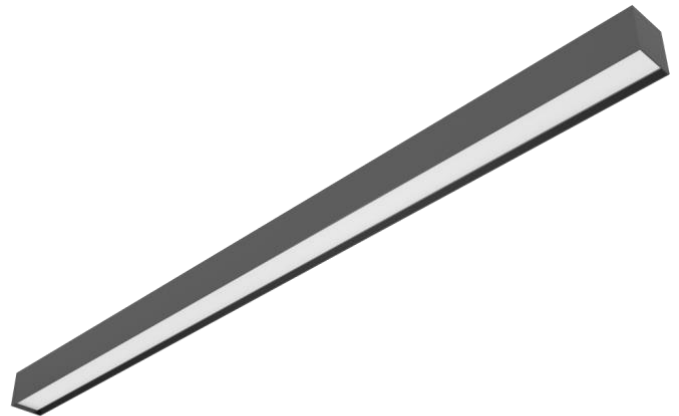
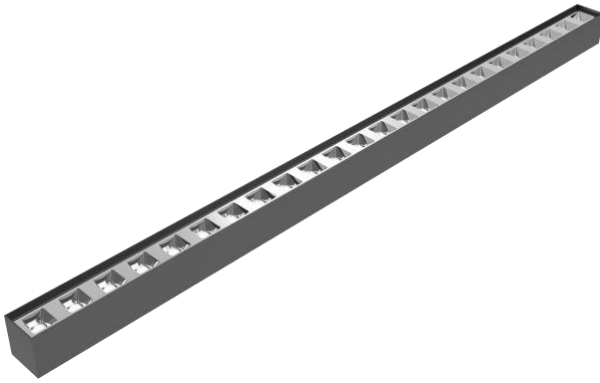

**Caution:**

- Please read the contents on the box and label carefully before installation
- Check if the specification e.g. voltage, current etc meet the requirements
- Power must be cut off before installation, replacement and cleaning
- Don't touch the luminaire while it is on or immediately after turning it off. Please wait 15 min. to cool down

**Remarks:**

- Power consumption tolerance: +/- 10%
- Luminous flux & cd tolerance: +/-10%

\*Photos, descriptions and details of the product are subject to change without previous notice.

## LED Fixed & Adjustable Spot Downlight K Series



### Benefits:

- Linear downlight enhancing contrast for horizontal surfaces & innovative antiglare screen
- Linear spotlight with tiltable or adjustable solution, excellent glare control & ultimate vertical illumination
- High visual comfort with maximum light output
- Easy to install and replace
- Overall cooling design
- Up to 80% energy saving, lower maintenance cost
- UV & IR free light
- Aluminum body + PMMA lens
- LUMINUS SMD3535 LED
- ON-OFF, DALI, 0-10V
- 120/220V
- Black or white trim + inner black body
- IP20
- SDCM<5
- 50.0000 hrs lifetime
- UGR<16

### Application:

- Hallways, Offices
- Stores, Shopping Centers
- Restaurants, Bars
- Hotels, Residential



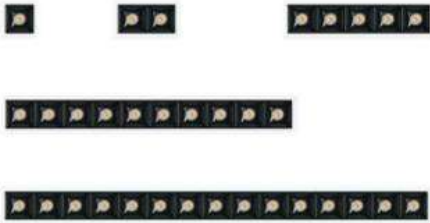

**Linear downlight**  
High-definition optics with excellent glare control. Louvre ensures precise circular distribution in accent lighting application, control UGR<10.



**Linear Spotlight**  
Tiltable function provides precise point-to-point illuminances with no spill light.

### LINEAR DOWNLIGHT FIXED



Item	Watt (W)	Luminous Flux (lm)	CRI (Ra)	CCT (K)	Cutout (mm)	Dimensions (mm)	Beam Angle
KLD-2W	2W	150lm	90	2700K-4000K	37*37	45*45*49	15°/30°/45°
KLD-4W	4W	300lm	90	2700K-4000K	68*37	75*45*49	15°/30°/45°
KLD-10W	10W	800lm	90	2700K-4000K	140*37	147*45*49	15°/30°/45°
KLD-20W	20W	1400lm	90	2700K-4000K	273*37	280*45*49	15°/30°/45°
KLD-30W	30W	2100lm	90	2700K-4000K	405*37	412*45*49	15°/30°/45°

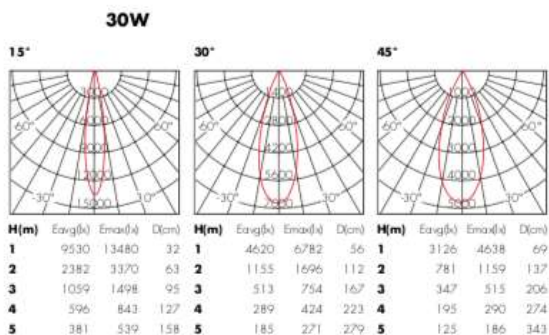
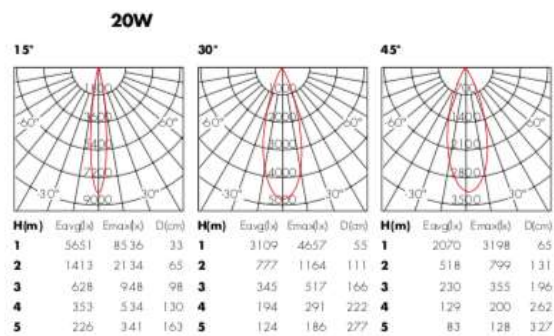
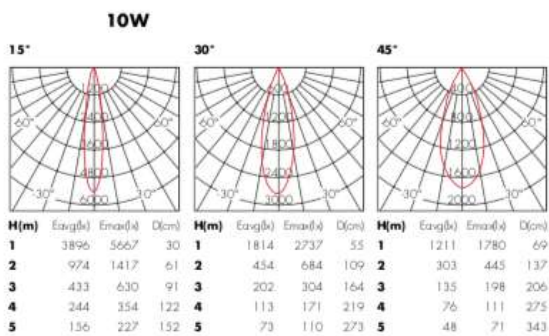
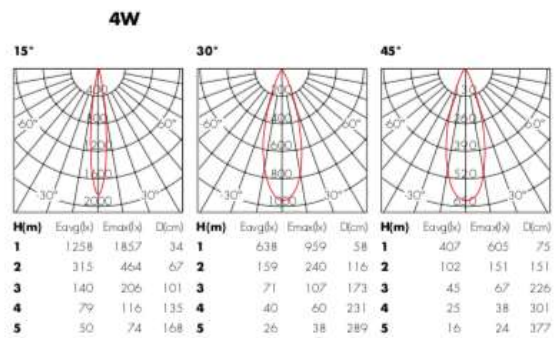
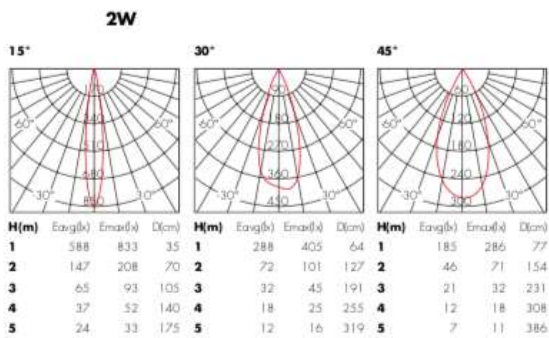

**LINEAR DOWNLIGHT TILTABLE ADJUSTABLE**



Item	Watt (W)	Luminous Flux (lm)	CRI (Ra)	CCT (K)	Cutout (mm)	Dimesions (mm)	Beam Angle
KLDA-2W	2W	150lm	90	2700K-4000K	55*45	65*60*49	15°/30°/45°
KLDA-4W	4W	300lm	90	2700K-4000K	68*45	95*60*49	15°/30°/45°
KLDA-10W	10W	800lm	90	2700K-4000K	155*45	167*60*49	15°/30°/45°
KLDA-20W	20W	1400lm	90	2700K-4000K	290*45	290*60*49	15°/30°/45°
KLDA-30W	30W	2100lm	90	2700K-4000K	425*45	425*45*49	15°/30°/45°



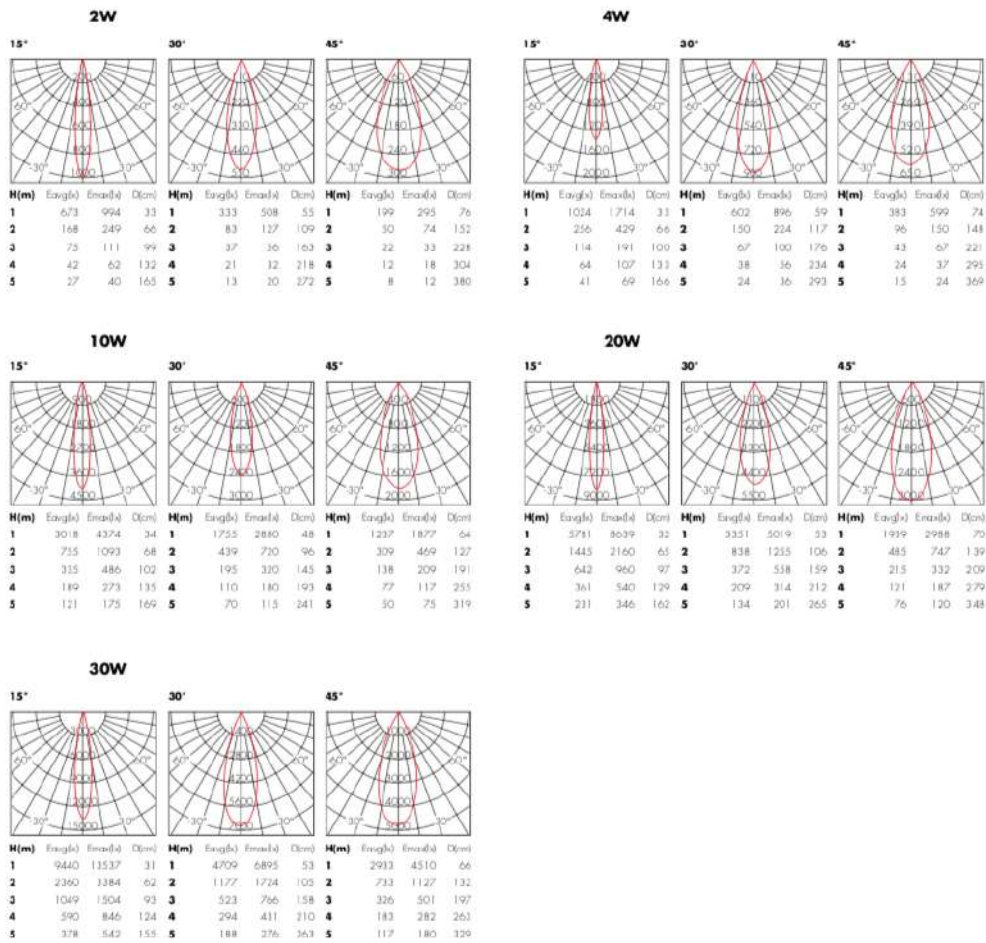

**Cautions:**

- Please read the contents on the box and label carefully before installation
- Check if the specification e.g. voltage, current etc meet the requirements
- Power must be cut off before installation, replacement and cleaning
- Don't touch the bulb/luminaire while it is on or immediately after turning it off. Please wait 15 min. for fixture to cool down.

**Remarks:**

- Power consumption tolerance: +/- 10%.
- Luminous flux tolerance: +/-10%

\*Photos, descriptions and details of the product are subject to change without previous notice.

## L65 Linear Light

IP65



### Product Features:

- Aluminum linear light with IP65 protection
- Reflector or opal diffuser
- 1135mm or 1415mm length available
- High efficiency and energy efficient
- On-Off, 0-10V or DALI
- Single or 3 CCT adjustable
- Connector available for continuing installation
- Low maintenance cost
- 120lm/W
- PF  $\geq 0.95$
- IK10
- Protection class I
- White, black or silver grey housing finishing
- 50000 hrs lifespan
- Surface-mount, wall or suspension installation
- 80° beam angle for reflector, 110° beam angle opal

**General Characteristics:**

PRODUCT CODE	POWER (W)	VOLTAGE	Lumen Output	CCT (K)	CRI	PRODUCT DIMENSION
L65-36	36W	100-240V/50-60Hz	4300lm	3000K/4000K/5700K	80	1135*65*75mm
L65-45	45W	100-240V/50-60Hz	5500lm	3000K/4000K/5700K	80	1415*65*75mm

**Dimensions:**

1135\*65\* 75mm

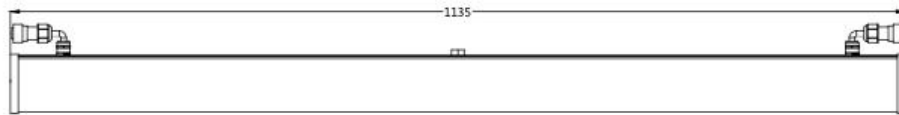
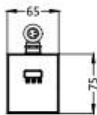

1415\*65\* 75mm

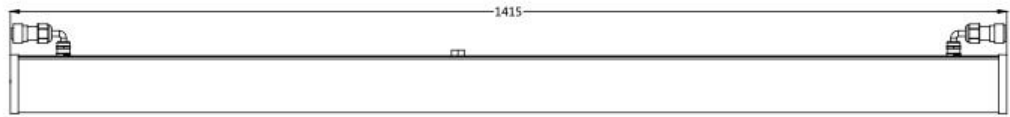
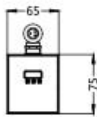

**Diagram:**

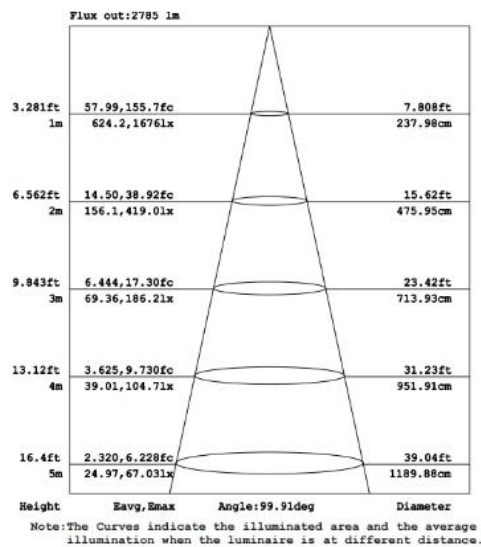
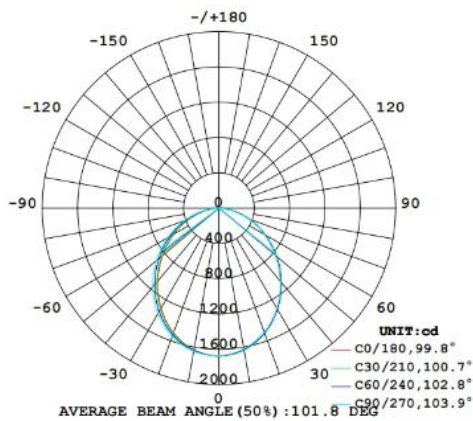

**Joint Connector:**

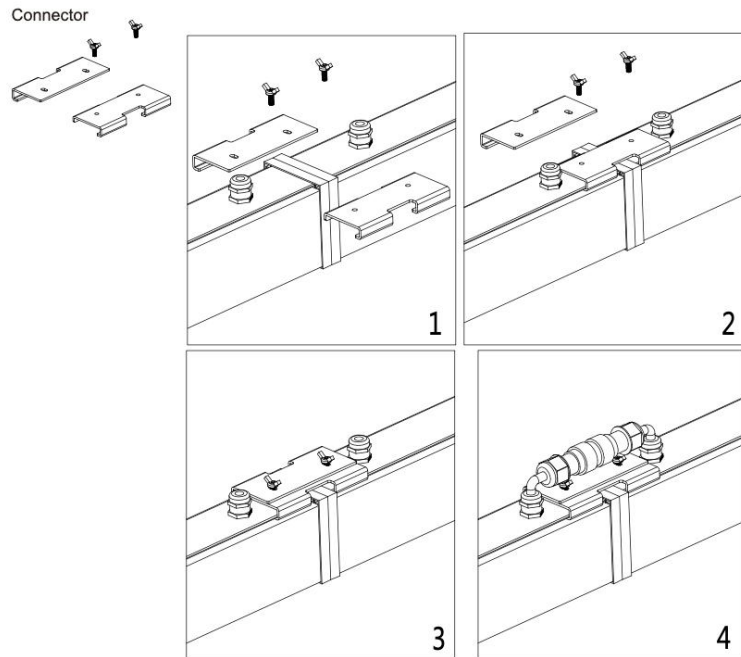

**Remarks:**

- 10% +/- tolerance: wattage, CCT, lumen output
- Lumen output depends on the fixture type, data is approximate
- Working temp. – 20°C + 40°C
- Storing temp. – 40°C + 60°C
- Working humidity 15% to 90% RH

Photos, descriptions & details of all panels are subject to change without previous notice.