

LED Strips

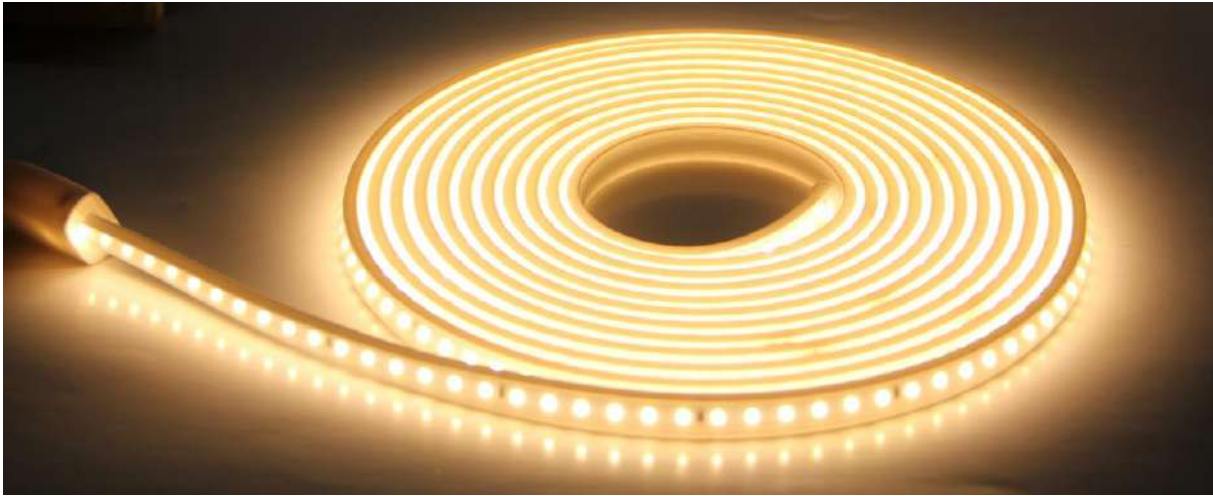

Benefits:

- For indoor & outdoor use
- Up to 15.5W/m & 1650lm
- Up to 80% energy saving
- Lower maintenance cost
- UV & IR free light
- CRI>80
- IP20, IP40, IP44, IP65
- 120V or 220V, 24V, or driverless (direct voltage)
- 2700K to 6500K

Applications:

- Linear light
- Indirect lighting
- Shops, stores
- Residential
- Restaurants, bars
- Hotels
- Garden, outdoor
- Offices



General Characteristics:

Item	Watt/M	Lumen/m	Voltage	CCT (K)	LED pcs/m	m/roll	Min. Cut Length
120V/220V IP20							
TLLSE-5	5W	400lm	120/220V	2700K-6500K	60	5m	1m
TLLSE-8	8W	700lm	120/220V	2700K-6500K	120	5m	1m
TLLSE-12	12W	1050lm	120/220V	2700K-6500K	180	5m	1m
24V IP44							
TLLSE-5.5	5.5W	550lm	24V	2700K-6500K	60	5m	5cm
TLLSE-8	8W	850lm	24V	2700K-6500K	120	5m	5cm
TLLSE-12	12W	1100lm	24V	2700K-6500K	120	5m	5cm
TLLSE-15.5	15.5W	1500lm	24V	2700K-6500K	120	5m	5cm
24V IP65							
TLLSE-5.5	5.5W	500lm	24V	2700K-6500K	60	5m	5cm
TLLSE-8	8W	800lm	24V	2700K-6500K	120	5m	5cm
TLLSE-12	12W	1000lm	24V	2700K-6500K	120	5m	5cm
TLLSE-15.5	15.5W	1400lm	24V	2700K-6500K	120	5m	5cm
Driverless 120V/220V IP40							
TLLSE-12	12W	1300lm	120/220V	2700K-6500K	120	50m	10cm
TLLSE-15	15W	1650lm	12V/220V	2700K-6500K	120	50m	10cm

LED Strips

Neon Flex

Our LED Neon Flex Strip is a perfect way to give a continuous smooth, linear lighting effect. It is easy to cut, bend and install. Its flexibility can make it easy to bend it into whatever angle or shape needed. This linear light is made of an inner plastic extrusion that houses the series of LED and a plastic outer jacket protecting the inner core. The plastic jacket is translucent colored and the LED's can be in different colors (red, orange, blue, yellow, green, etc) and white tones.

Benefits:

- For indoor & outdoor use
- Flexible
- Low heat & safe
- Up to 80% energy saving
- Lower maintenance cost
- UV & IR free light
- CRI>80 or CRI>90
- 50.000 hrs life-span
- Single or double side light emission

Applications:

- Reading & task lighting
- Cove lighting
- Accent lighting
- Edge lighting
- Under counter lighting
- Stair lighting

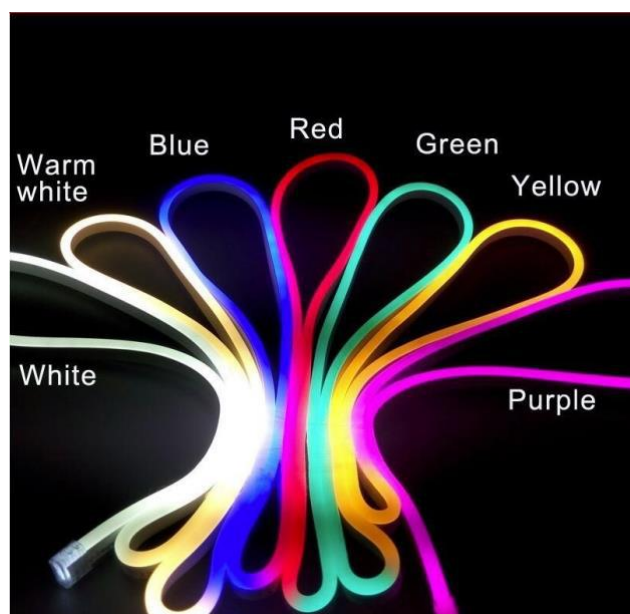
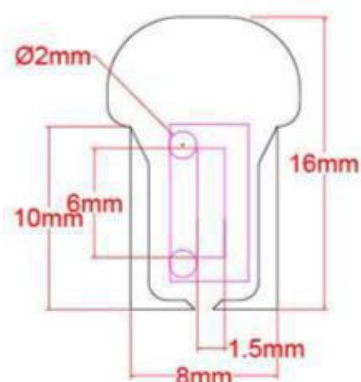

Characteristics:

- 12V, 24V, 120V, 220V, OR 277V*
- Working am: 15-17mA/meter (220V)
- LED number: 120 LEDs/meter for single colored – 60 LEDs/meter for RGB
- LED: SMD 2835
- Colors: White, warm white, red, green, blue, yellow, pink, purple, RGB
- Beam angle: 120°
- Operation temp.: -40°C up to 80°C
- Body temp.: 40°C up to 60°C
- IP65, IP67*, IP68*
- Shell material: Integration D shaped PVC
- Accessories: Power cord, male-male plug, U aluminum channel or U PVC channel, metal pin, connector, heat shrink cap, end cap, controller

Power/M:

- Red, Yellow, Blue, Green, White, Warm White, Purple
 - AC220V + 110V – 6W/M
 - DC24V + 12V – 8W/M
- RGB
 - AC220V + 110V – 6W/M
 - DC24V – 11W/M

Cutting:

- Red, Yellow, Blue, Green, White, Warm White, Purple
 - AC220V – 100cm
 - AC110V – 50cm
 - DC24V – 50cm
 - DC12V – 5cm
- RGB
 - AC220V – 100cm
 - AC110V – 50cm
 - DC24V – 50cm

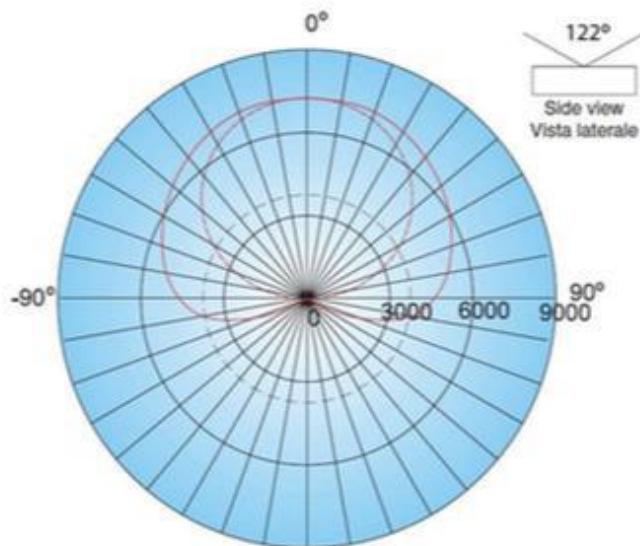
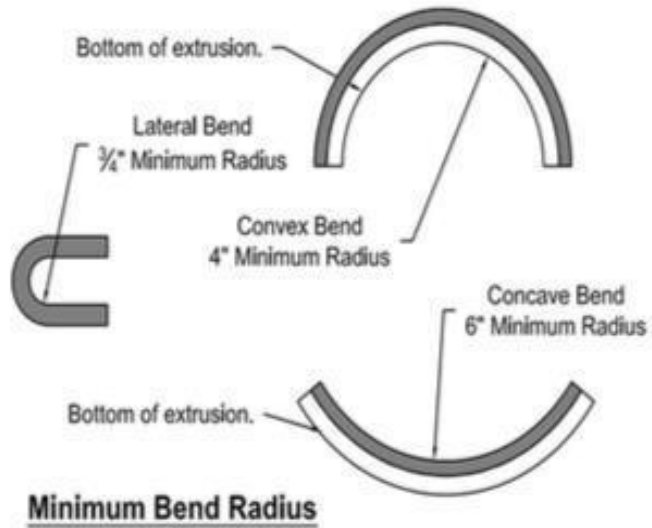

*Photos, descriptions and details of the product are subject to change without previous notice.

*277V special upon request. Size 14*26mm.

*Strip is IP68 excluding the connection part to the power cord (IP65).

*After cutting strips & re-wiring, the cuttable point becomes IP65.

*Most suitable & recommended for use as IP65.

LED Strips

Neon Flex 360° Omni-Directional

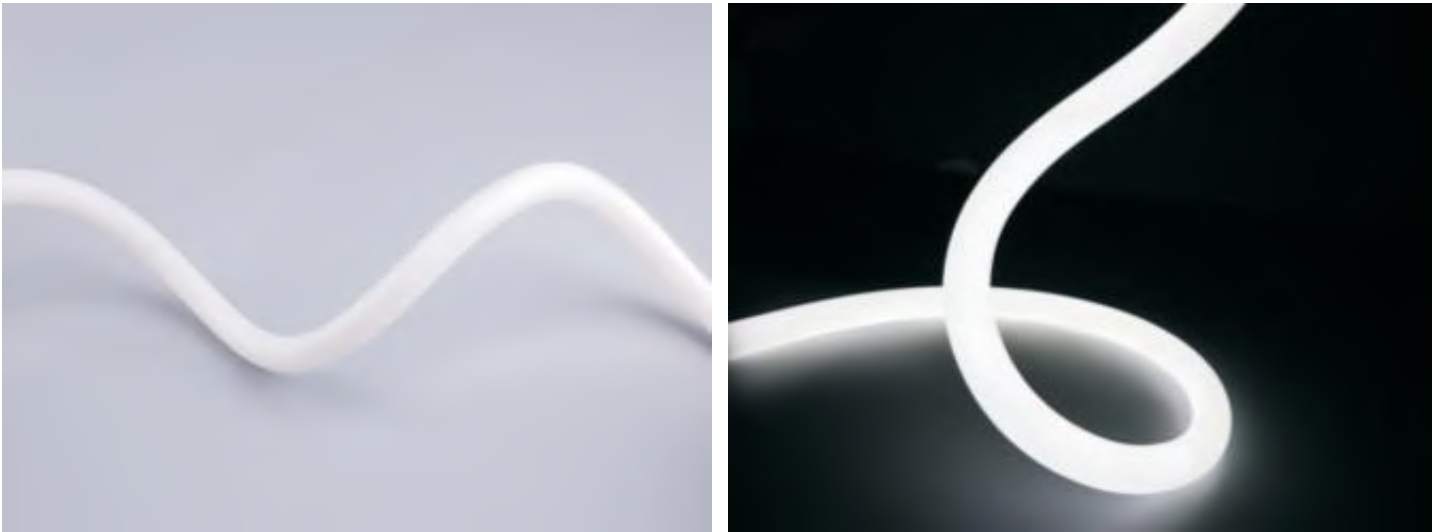

Benefits:

- Circular tube design with omni-directional 360 degrees light emission
- Uniform, dot-free light effect
- Smooth & comfortable light performance
- Up to 5 meters long
- Cuttable with end cap glue sealing or die-casting process
- Dimmable with PWM also available
- Silicon extrusion technology, highly efficient & environment-friendly
- High grade appearance, soft bend flexibility, strong impact & weather resistance
- Surface mount or ceiling installation by bracket or clip
- Suspension installation by using an extra suspension kit
- Diameter of 18mm
- IP65



Characteristics:

- 12W/m
- 24V DC
- 2700K to 6500K
- 1150lm/m
- 96lm/W
- SMD2216
- CRI80
- 480LED/m
- Working temperature: -20C to 45C
- Storage temperature: -20C to 60C
- 50.000 hrs for indoor & 36.000 hrs for outdoor

(1) Power cable in rear feed.



(2) Surface mounting by bracket.

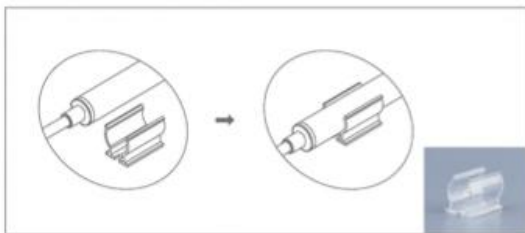

(3) Surface mounting or ceiling mounting by clip.

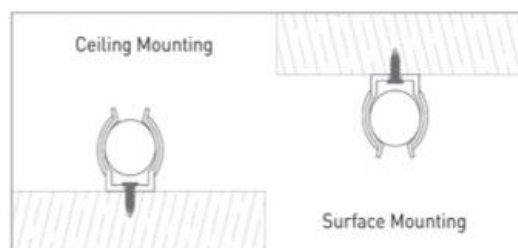
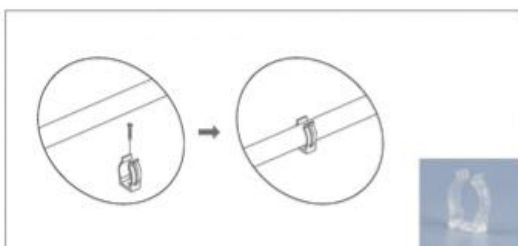

[4] Ceiling mounting by suspension kit.

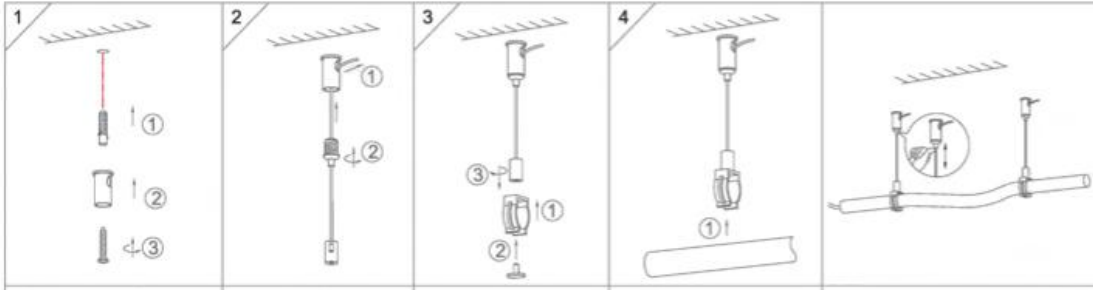

Cautions:

- Please read the contents on the box and label carefully before installation.
- Check if the specification e.g. voltage, current etc meet the requirements.
- Power must be cut off before installation, replacement and cleaning.

Remarks:

- Power consumption tolerance: +/- 10%.
- Luminous flux & cd tolerance: +/-10%.

LED Strips

Neon Flex D Series



Features:

- Uniform, dot free, smooth & comfortable light up to 20 mts length
- Silicon extrusion technology with high efficiency
- Soft bend flexibility, strong impact resistant
- Wide beam angle light distribution
- IP65 with gluing process for outdoor use
- IP40 without gluing process for indoor use
- Lower maintenance cost
- UV & IR free light
- CRI>80
- 50.000 hrs lifespan for indoor use
- 36.000 hrs lifespan for outdoor use
- Free cutting to any length required
- White CCT or RGB
- Different installation methods & accessories available
- Top & side bend

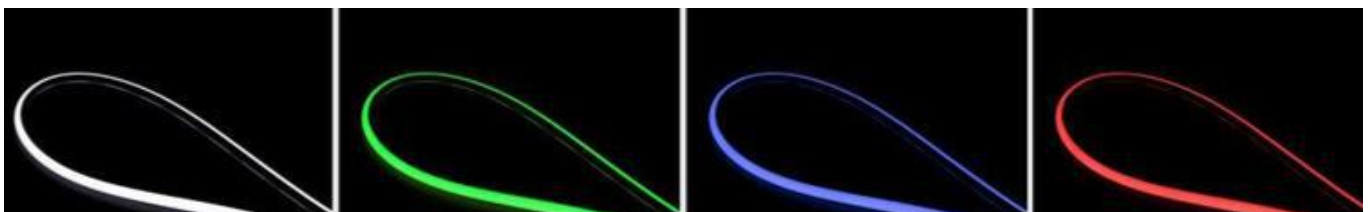

Characteristics:

- 9W/m, 14W/m
- 24V
- 2700K-6000K
- Red, green, blue, pink or RGB
- SMD3528 or SMD4040
- 120 LEDs/m
- Dimensions:
W:16mm H:15mm
W: 10mm H:20mm
- Maximum length: 20 mts
- Operating temperature: -20°C to 45°C
- L70B50 @ Tc max. 65°C (LED pin temperature)
- Up to 900-1000lm/m
- 120°/180°

- Free cutting in any position and



- Different directions for power feeds



- Joint connector available



- Jumper accessories



Installation:

- Clip & screw

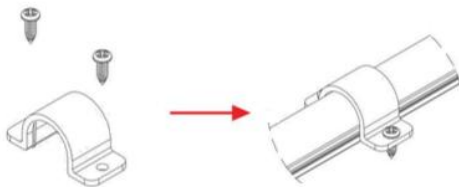

- Bracket & screw

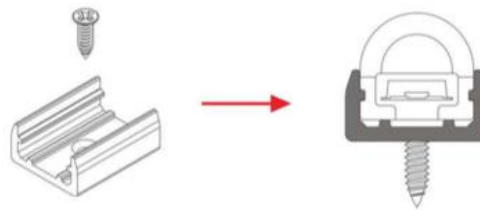

- Aluminum & screw

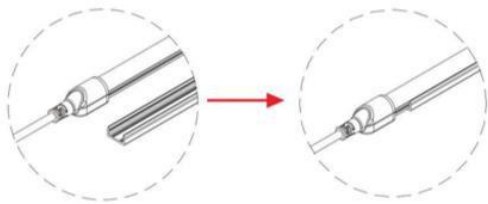

- Fixed bendable bracket

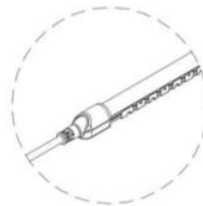

Remarks:

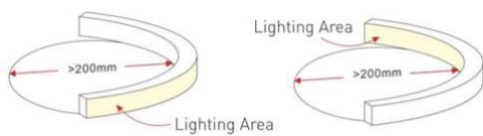

LED Strips

Neon Flex P Series



Features:

- Flat LED profile offering uniform, dot free, smooth & comfortable light up to 20 mts length
- Silicon extrusion technology with high efficiency
- Soft bend flexibility, strong impact resistant
- Wide beam angle light distribution
- IP65 with gluing process for outdoor use
- IP40 without gluing process for indoor use
- Lower maintenance cost
- UV & IR free light
- CRI>80
- 50.000 hrs lifespan for indoor use
- 36.000 hrs lifespan for outdoor use
- Free cutting to any length required
- White CCT or RGB
- Different installation methods & accessories available
- Top & side bend



Characteristics:

- 9W/m, 14W/m
- 24V
- 2700K-6000K
- Red, green, blue, pink or RGB
- SMD3528 or SMD4040
- 120 LEDs/m
- Dimensions:
W:16mm H:12mm
W: 8.8mm H:16.5mm
- Maximum length: 20 mts
- Operating temperature: -20°C to 45°C
- L70B50 @ Tc max. 65°C (LED pin temperature)
- Up to 700-800lm/m
- 120°

- Free cutting in any position and



- Different directions for power feeds



- Jumper accessories



Installation:

- Clip & screw

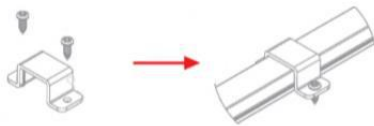

- Bracket & screw

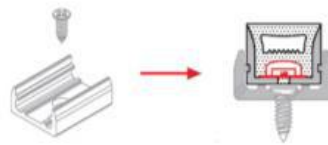

- Aluminum & screw

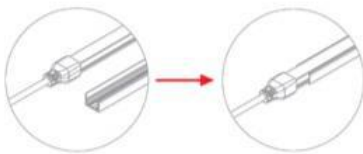

- Fixed bendable bracket



Remarks:

